

Ilanngussaq 1 Kommune Kujallermi utoqqarnut inissianik, utoqqaat angerlarsimaffiinik utoqqarnullu najugaqatigiiffinnik pisariitsumik takusassiineq

Nanortalik B-1391	Utoqqarnut inissiaq	1991	58	-	0	259.00	2	6,6	185.440	2	6,5	206.440
Nanortalik B-1392	Utoqqarnut inissiaq	1991	58	-	0	264.60	2	6,6	185.440	2	6,5	206.440
Alluitsup Paa B-1247	Utoqqarnut angerlarsimaffik	0	300	661.075	936.000			Ilaassanngil aq	Ilaassanngil aq	Ilaassanngil aq		Ilaassanngila q
Eqalugaarsuit B-1190	Utoqqarnut najugaqatigiiffik	0	194	389.650	293.200			Ilaassanngil aq	Ilaassanngil aq	Ilaassanngil aq		Ilaassanngila q
Nanortalik B-1494	Utoqqarnut angerlarsimaffik	0	160	420.000	719.000			Ilaassanngil aq	Ilaassanngil aq	Ilaassanngil aq		Ilaassanngila q
Narsaq B-700	Utoqqarnut angerlarsimaffik	1967	1693	54.000	1.877.000			Ilaassanngil aq	Ilaassanngil aq	Ilaassanngil aq		Ilaassanngila q

Nanortalik B-929	Utoqqarnut angerlarsimaffik	1967	800				Ilaassanngil aq	Ilaassanngil aq	Ilaassanngil aq	Ilaassanngila q
				72.000	4.904.000					
Igaliku B-1178	Utoqqarnut inissiaq	1983	55				7,0	280.900	5	6,5
				126.200	475.000	5				292.000
Igaliku B-1179	Utoqqarnut inissiaq	1983	55				7,0	280.900	5	6,5
				176.300	127.000	5				292.000
Qassiarsuk B-1161	Utoqqarnut inissiaq	1986	56				7,0	280.900	5	6,5
				198.100	132.000	5				292.000

61

iTWOfm nanvn	Atorneqarnera	sananeqarfia	m ²	Kinguaattoorneq katillugit	Aserfallatsaaliineq katillugit	Utoqqarnut inissiatut pitsaassusaanut naliilneq	Inissiap 10-mik nalilerneqarsinnaasunngor-tinnissaanut akia	Innarluutiinnut piukkunnassusaanut naliilneq	Innarluutiinnut piukkunnarsannaat qaavatigut akia
Qassiarsuk B-1162	Utoqqarnut inissiaq	1986	56			7,05		6,55	
				147.350	181.000		280.900		292.000
Qassiarsuk B-1234	Utoqqarnut inissiaq	1989	56			7,05		6,55	
				181.200	194.500		280.900		292.000

2

Qassarsuk B-1235	Utoqqarnut inissiaq	1989	56		84.200	288.000	7,05	280.900	6,55	292.000
Narsaq B-1120-A	Utoqqarnut inissiaq	1976	42,2		99.900	398.500	6,91	276.980	7,01	291.980
Narsaq B-1094-1	Utoqqarnut inissiaq	1982	42,2		-	369.700	6,91	276.980	7,01	291.980
Narsaq B-1094-2	Utoqqarnut inissiaq	1982	42,2		10.000	375.200	6,91	275.980	7,01	291.980
Narsaq B-1120-B	Utoqqarnut inissiaq	1984	42,2		195.000	274.500	6,91	276.980	7,01	291.980
Narsaq B-1121-A	Utoqqarnut inissiaq	1984	42,2		40.000	492.000	6,91	276.980	7,01	291.980
Narsaq B-1121-B	Utoqqarnut inissiaq	1984	42,2		40.000	703.250	6,91	276.980	7,01	291.980
Narsaq B-1135-A	Utoqqarnut inissiaq	1984	42,2		-	807.550	6,91	276.980	7,01	291.980
Narsaq B-1135-B	Utoqqarnut inissiaq	1984	42,2		-	215.800	6,91	276.980	7,01	291.980
Narsaq B-1136-A	Utoqqarnut inissiaq	1984	42,2		1.800	605.500	6,91	276.980	7,01	291.980
Narsaq B-1136-B	Utoqqarnut inissiaq	1984	42,2				6,91		7,01	

iTWOfm nanvn	Atorneqarnera	sananeqarfia	m ²	Kinguaattoorneq katillugit	Aserfallatsaaliineq katillugit	Utoqqarnut inissiatut pitsaassusaanut naliineq	Inissiap 10-mik nailierneqarsinnaasunngor-tinnissaanut akia	Innarluutilinnut piukkunnassusaanut naliineq	Innarluutilinnut piukkunnarsannaasut qaavatigut akia
--------------	---------------	--------------	----------------	----------------------------	--------------------------------	--	---	--	--

				-	629.500		276.980		291.980
Qaqortoq B-1148	Utoqqarnut inissiaq	1982	58	15.000	302.000	8,71	72.000	8,21	-
Qaqortoq B-1149	Utoqqarnut inissiaq	1982	58	10.500	301.500	8,71	72.000	8,21	-
Qaqortoq B-1150	Utoqqarnut inissiaq	1982	58	-	390.900	8,72	79.000	8,49	84.000
Qaqortoq B-1151	Utoqqarnut inissiaq	1982	58	307.650	191.100	8,72	79.000	8,49	84.000
Qaqortoq B-1152	Utoqqarnut inissiaq	1982	58	-	408.000	8,72	79.000	8,49	84.000
Narsaq B-1414-A	Utoqqarnut inissiaq	2006	58,73	-	373.000	8,5	56.600	8,5	111.600
Narsaq B-1414-B	Utoqqarnut inissiaq	2006	58,73	-	257.300	8,5	56.600	8,5	111.600
Narsaq B-1467-1	Utoqqarnut inissiaq	2006	55	1.000	226.100	8,5	56.600	8,5	111.600
Qaqortoq B-1320	Utoqqarnut angerlarsimaffik	1990	2708	8.064.400	4.886.000	0	-	-	-
Narsaq B-1467-2	Utoqqarnut inissiaq	2006	55	18.000	243.500	8,5	56.600	8,5	111.600

Narsaq B-1468-1	Utoqqarnut inissiaq	2006	55	1.000	235.000	8,5	56.600	8,5	111.600
Narsaq B-1468-2	Utoqqarnut inissiaq	2006	55	6.000	174.000	8,5	56.600	8,5	111.600

iTWOfm nanvn	Atoqqarnut	sananeqarfia	m ²	Kinguaattoorneq katillugit	Aserfallatsaaliineq katillugit	Utoqqarnut inissiatut pitsaassusaanut naliineq	Inissiap 10-mik nalilerneqarsinnaasunngortinnissaanut akia	Innarluutilinnut piukkunnassusaanut naliineq	Innarluutilinnut piukkunnarsannaasut qaavatigut akia
Qaqortoq B-1564-3	Utoqqarnut inissiaq	2004	61,6	-	145.100	8,6	76.000	8,6	121.000
Qaqortoq B-1564-4	Utoqqarnut inissiaq	2004	61	46.650	126.100	8,6	76.000	8,6	121.000
Qaqortoq B-1564-5	Utoqqarnut inissiaq	2004	61	32.300	125.000	8,6	76.000	8,6	121.000
Qaqortoq B-1564-6	Utoqqarnut inissiaq	2004	61,6	79.300	132.800	8,6	76.000	8,6	121.000
Qaqortoq B-1565-10	Utoqqarnut inissiaq	2004	61,6	97.800	45.500	8,6	76.000	8,6	121.000
Qaqortoq B-1565-7	Utoqqarnut inissiaq	2004	61,6	65.000	83.000	8,6	76.000	8,6	121.000
Qaqortoq B-1565-8	Utoqqarnut inissiaq	2004	61	148.850	114.000	8,6	76.000	8,6	121.000
Qaqortoq B-1565-9	Utoqqarnut inissiaq	2004	61	97.800	99.800	8,6	76.000	8,6	121.000

Nanortalik B-1639-1	Utoqqarnut inissiaq	2008	60,6	-	191.450	9,3	58.000	8,6	119.000
Nanortalik B-1639-2	Utoqqarnut inissiaq	2008	60,6	-	222.000	9,3	58.000	8,6	119.000
Qaqortoq B-1563-1	Utoqqarnut inissiaq	0	61,6	-	219.000	8,7	62.000	8,7	107.000
Qaqortoq B-1563-2	Utoqqarnut inissiaq	0	61,4	-	212.000	8,7	62.000	8,7	107.000
Qaqortoq B-1410	Utoqqarnut inissiaq	1997	57,3			8,7		8,7	

iTWOfm nanvn	Atorneqarnera	sananeqarfia	m ²	Kinguaattoorneq katillugit	Aserfallatsaaliineq katillugit	Utoqqarnut inissiatut pitsaassusaanut naliineq	Inissiap 10-mik nalilerneqarsinnaasunngortinnissaanut akia	Innarluutilinnut piukkunnassusaanut naliineq	Innarluutilinnut piukkunnarsannaasut qaavatigut akia
				65.000	116.400		62.000		107.000
Qaqortoq B-1411	Utoqqarnut inissiaq	1997	57,3	35.000	146.400	8,7	62.000	8,7	107.000
Qaqortoq B-1412	Utoqqarnut inissiaq	1997	57,3	190.100	73.000	8,6	69.000	8,7	64.000
Qaqortoq B-1413	Utoqqarnut inissiaq	1997	57,3	18.600	126.000	8,6	69.000	8,7	64.000
Qaqortoq B-1414	Utoqqarnut inissiaq	1997	57,3	165.000		8,6	69.000	8,7	64.000

					35.800				
Qaqortoq B-1415	Utoqqarnut inissiaq	1998	57,3	186.200	63.000	8,6	69.000	8,7	64.000
Qaqortoq B-1416	Utoqqarnut inissiaq	1998	57,3	118.050	37.000	8,6	69.000	8,7	64.000
Qaqortoq B-1417	Utoqqarnut inissiaq	1998	57,3	84.450	32.550	8,6	69.000	8,7	64.000
Qaqortoq B-1418	Utoqqarnut inissiaq	1998	57,3	81.200	63.000	8,6	69.000	8,7	64.000
Qaqortoq B-1419	Utoqqarnut inissiaq	1998	57,3	132.300	79.000	8,6	69.000	8,7	64.000
Qaqortoq B-1145	Utoqqarnut inissiaq	1982	58	-	326.000	8,82	72.000	8,79	127.000
Qaqortoq B-1146	Utoqqarnut inissiaq	1982	58	-	310.900	8,82	72.000	8,79	127.000
Qaqortoq B-1147	Utoqqarnut inissiaq	1982	58	-	328.000	8,82	72.000	8,79	127.000

iTWOfm nanvn	Atorneqarnera	sananeqarfia	m ²	Kinguaattoorneq katillugit	Aserfallatsaaliineq katillugit	Utoqqarnut inissiatut pitsaassusaanut naliiineq	Inissiap 10-mik nalilerneqarsinnaasunngor-tinnissaanut akia	Innarluutilinnut piukkunnassusaanut naliiineq	Innarluutilinnut piukkunnarsannaasut qaavatigut akia
Nanortalik B-1602-1	Utoqqarnut inissiaq	2007	58,4	-	176.450	9,4	76.300	9,4	76.300
Nanortalik B-1602-2	Utoqqarnut inissiaq	2007	58,4	-	195.050	9,4	76.300	9,4	76.300
Nanortalik B-1602-3	Utoqqarnut inissiaq	2007	58,4	5.700	232.200	9,4	76.300	9,4	76.300
Nanortalik B-1602-4	Utoqqarnut inissiaq	2007	58,4	5.000	224.600	9,4	76.300	9,4	76.300

Ilanngussaq 2 Kommuneqarfik Sermersuumi utoqqarnut inissianik, utoqqaat angerlarsimaffiik utoqqarnullu najugaqatigiiffinnik pisariitsumik takusassiineq

iTWOfm nanvn	Atorneqarnera	sananeqarfia	m ²	Kinguaattoorneq katillugit	Aserfallatsaaliineq katillugit	Utoqqarnut inissiatut pitsaassusaanut naliilneq	Inissiap 10-mik nailerneqarsinnaasunngor -tinnissaanut akia	Innarluutilinnut piukkunnassusaanut naliilneq	Innarluutilinnut piukkunnarsarnissaanut qaavatiqut akia
Nuuk B-4023	Utoqqarnut angerlarsimaffik	-	1872	20.500	2.045.300	Ilaassanngilaq	Ilaassanngilaq	Ilaassanngilaq	Ilaassanngilaq
Tasiilaq B-183	Utoqqarnut angerlarsimaffik	1961	870	275.850	1.638.150	Ilaassanngilaq	Ilaassanngilaq	Ilaassanngilaq	Ilaassanngilaq
Nuuk B-1483	Utoqqarnut angerlarsimaffik	1968	3336	481.000	4.566.900	Ilaassanngilaq	Ilaassanngilaq	Ilaassanngilaq	Ilaassanngilaq
Nuuk B-3106	Utoqqarnut angerlarsimaffik	1998	754	393.000	840.000	Ilaassanngilaq	Ilaassanngilaq	Ilaassanngilaq	Ilaassanngilaq
Nuuk B-3107	Utoqqarnut angerlarsimaffik	1998	1607	431.800	1.513.200	Ilaassanngilaq	Ilaassanngilaq	Ilaassanngilaq	Ilaassanngilaq
Paamiut B-129	Utoqqarnut angerlarsimaffik	2019	1952	-	3.561.000	Ilaassanngilaq	Ilaassanngilaq	Ilaassanngilaq	Ilaassanngilaq
Nuuk B-440 m. Iniss. nr. 069,071,073 aamma nr. 075	Utoqqarnut inissiaq	1961	164	18.000	1.928.000	4,09	366.300	3,86	417.400
Nuuk 497-4 blok N. Iniss. nr. 043,045 aamma nr. 047	Utoqqarnut inissiaq	1963	215	119.200	512.400	5,78	247.600	4,34	320.000

Nuuk 496-6 blok M. Iniss. nr. 001,003,005,009 aamma nr. 011	Utoqqarnut inissiaq	1963	290	36.500	869.000	5,06	334.500	3,82	366.900
Nuuk B-498-2 blok O.	Utoqqarnut	1963	464	4.400	569.000	4,24	444.300	2,9	485.600

iTWOfm nanvn	Atorneqarnera	sananeqarfia	m ²	Kinguaattoorneq katillugit	Aserfallatsaaliineq katillugit	Utoqqarnut inissiatut pitsaassusaanut nalliineq	Inissiap 10-mik nalilerneqarsinnaasungor -tinnissaanut akia	Innarluutilinnut piukkunnassusaanut nalliineq	Innarluutilinnut piukkunnarsannaasut qaavatiqut akia
Iniss. nr. 085,087,089,091,093,097 aamma nr. 099	inissiaq								
Nuuk B-1765 16 A (illut affarleriit)	Utoqqarnut inissiaq	1977	97,8	110.000	115.000	5,83	333.000	5,51	-
Nuuk B-1766 18 B (illut affarleriit)	Utoqqarnut inissiaq	1977	97,8	179.700	55.000	5,83	333.000	5,51	-
Nuuk B-1767 20 B (illut affarleriit)	Utoqqarnut inissiaq	1977	97,8	144.800	110.000	5,83	333.000	5,51	-
Nuuk B-1762 10A (illut affarleriit)	Utoqqarnut inissiaq	1977	97,8	119.400	110.000	6,03	354.000	5,43	-
Nuuk B-2093	Utoqqarnut inissiaq	1983	440	210.000	503.100	7,18	149.600	7,06	159.600
Nuuk B-2030 A-B-C-D-E	Utoqqarnut inissiaq	1985	242	384.900	377.900	6,03	255.000	5,93	-
Nuuk B-2211 A-B-C	Utoqqarnut inissiaq	1985	145,2	149.100	224.000	6,03	255.000	5,93	305.000

Nuuk B-2212 A-B	Utoqqarnut inissiaq	1985	96,8	264.800	122.500	6,03	255.000	5,93	305.000
Kuummiut B-1351	Utoqqarnut inissiaq	1993	43	25.700	269.650	7,1	197.440	5,35	-
Kuummiut B-1352	Utoqqarnut inissiaq	1993	43	-	259.600	7,1	197.440	5,35	-
Kuummiut B-1353	Utoqqarnut inissiaq	1993	43	18.000	248.000	7,1	197.440	5,35	-

iTWOfm nanvn	Atorneqarnera	sananeqarfia	m ²	Kinguaattoorneq katillugit	Aserfallatsaaliineq katillugit	Utoqqarnut inissiatut pitsaassusaanut naliilneq	Inissiap 10-mik nalilerneqarsinnaasungor -tinnissaanut akia	Innarluutilinnut piukkunnassusaanut naliilneq	Innarluutilinnut piukkunnarsannaanut qaavatigut akia
Kuummiut B-1354	Utoqqarnut inissiaq	1993	43	54.000	208.600	7,1	197.440	5,35	-
Tasiilaq B-1328	Utoqqarnut inissiaq	1993	43	4.100	201.310	6,59	208.440	5,75	-
Tasiilaq B-1329	Utoqqarnut inissiaq	1993	43	350	209.230	6,59	208.440	5,75	-
Tasiilaq B-1330	Utoqqarnut inissiaq	1993	43	9.200	225.000	6,59	208.440	5,75	-
Tasiilaq B-1331	Utoqqarnut inissiaq	1993	43	750	175.090	6,59	208.440	5,75	-
Tasiilaq B-1333	Utoqqarnut inissiaq	1993	43	3.600	203.930	6,59	208.440	5,75	-
Tasiilaq B-1332	Utoqqarnut	1993	43	200	202.430	6,59	268.440	5,25	-

	inissiaq								
Nuuk B-2930 Iniss. nr. 79 aamma 89	Utoqqarnut inissiaq	1993	100	1.200	2.172.000	6,55	249.000	5,33	277.000
Nuuk B-2927 m. iniss. nr. 45 aamma 57.	Utoqqarnut inissiaq	1993	50	17.900	223.250	6,55	335.800	5,33	277.000
Nuuk B-2926	Utoqqarnut inissiaq	1993	50	114.700	82.250	6,65	298.000	5,83	277.000
Nuuk B-2934	Utoqqarnut inissiaq	1993	50	1.800	246.500	6,65	319.000	5,83	277.000
Nuuk B-2928	Utoqqarnut inissiaq	1993	50	2.900	141.000	6,55	331.600	5,33	277.000
Nuuk B-2931	Utoqqarnut	1993	50	40.000	221.000	6,45	301.900	5,73	281.000

iTWOfm nanvn	Atorneqarnera	sananeqarfia	m ²	Kinguaattoorneq katillugit	Aserfallatsaaliineq katillugit	Utoqqarnut inissiatut pitsaassusaanut nalliineq	Inissiap 10-mik nalilernegarsinnaasungor -tinnissaanut akia	Innarluutilinnut piukkunnassusaanut nalliineq	Innarluutilinnut piukkunnarsannaanut qaavatiqut akia
	inissiaq								
Nuuk B-2924	Utoqqarnut inissiaq	1993	50	67.302	126.000	6,45	249.500	5,43	286.000
Paamiut B-993	Utoqqarnut inissiaq	1993	464	-	1.712.050	7,29	196.000	5,79	294.000
Paamiut B-992	Utoqqarnut inissiaq	1993	278,4	148.675	1.240.000	7,29	196.000	5,79	294.000

Nuuk B-2935	Utoqqarnut inissiaq	1993	50	-	329.500	6,49	345.000	5,67	324.000
Kulusuk B-1394	Utoqqarnut inissiaq	1995	43	2.000	243.600	6,24	236.440	5	-
Kulusuk B-1395	Utoqqarnut inissiaq	1995	43	18.700	398.100	6,24	236.440	5	-
Kulusuk B-1396	Utoqqarnut inissiaq	1995	43	17.500	203.100	6,24	236.440	5	-
Nuuk B-3021	Utoqqarnut inissiaq	1995	189,4	9.500	254.900	7	188.600	6,2	206.600
Isortoq B-1462	Utoqqarnut inissiaq	1996	43	42.700	219.750	6,7	147.750	5,36	-
Isortoq B-1463	Utoqqarnut inissiaq	1996	43	38.700	219.750	6,7	147.750	5,36	-
Isortoq B-1464	Utoqqarnut inissiaq	1996	43	203.850	217.650	6,7	147.750	5,36	-
Isortoq B-1465	Utoqqarnut inissiaq	1996	43	40.500	239.250	6,7	147.750	5,36	-

iTWOfm nanvn	Atorneqarnera	sananeqarfia	m ²	Kinguaattoorneq katillugit	Aserfallatsaaliineq katillugit	Utoqqarnut inissiatut pitsaassusaanut naliliineq	Inissiap 10-mik nalilerneqarsinnaasunngor -tinnissaanut akia	Innarluutilinnut piukkunnassusaanut naliliineq	Innarluutilinnut piukkunnarsamissaanut qaavatigut akia
Nuuk B-3073 m. Iniss. nr. 001,002,003 aamma nr. 004	Utoqqarnut inissiaq	1997	280	11.660	641.350	6,76	251.400	5,25	253.000

Tiniteqilaaq B-1506	Utoqqarnut inissiaq	1998	57	218.900	147.450	7	125.750	6,16	-
Tiniteqilaaq B-1507	Utoqqarnut inissiaq	1998	57	-	197.300	7	125.750	6,16	-
Nuuk B-3093 m. Iniss. nr. 001,002,003 aamma nr. 004	Utoqqarnut inissiaq	1998	280	7.860	500.860	6,96	210.300	5,35	248.000
Nuuk B-3128	Utoqqarnut inissiaq	1999	637,2	7.500	715.560	9,6	57.000	9,1	112.000
Nuuk B-3129	Utoqqarnut inissiaq	1999	424,8	5.000	555.300	9,6	67.000	9	112.000
Nuuk B-3130	Utoqqarnut inissiaq	1999	424,8	8.000	574.000	9,6	57.000	9,1	112.000
Sermiligaaq B-1521	Utoqqarnut inissiaq	2000	57	1.000	204.050	6,5	81.000	5,16	-
Sermiligaaq B-1522	Utoqqarnut inissiaq	2000	57	1.650	205.100	6,5	136.750	5,16	-
Sermiligaaq B-1523	Utoqqarnut inissiaq	2000	57	10.000	204.100	6,5	136.750	5,16	-
Sermiligaaq B-1524	Utoqqarnut inissiaq	2000	57	20.000	220.600	6,5	136.750	5,16	230.750
Ittoqqortoormiit B-255	Utoqqarnut	1980	332	111.000	520.000	Ilaassanngilaq	Ilaassanngilaq	Ilaassanngilaq	Ilaassanngilaq

iTWOfm nanvn

Atorneqarnera

sananeqarfia

m²

Kinguaattoorneq katillugit

Aserfallatsaaliineq katillugit

Utoqqarnut inissiatut pitsaassusaanut naliliineq

Inissiap 10-mik nalilernegarsinnaasunngor -tinnissaanut akia

Innarluutilinnut piukkunnassusaanut naliliineq

Innarluutilinnut piukkunnarsarnissaanut qaavatiqut akia

	najugaqatigiiffik								
Nuuk B-2439	Utoqqarnut najugaqatigiiffik	1987	525	990.700	1.430.000	Ilaassanngilaq	Ilaassanngilaq	Ilaassanngilaq	Ilaassanngilaq

Ilanngussaq 3 Qeqqata Kommunianni utoqqarnut inissianik, utoqqaat angerlarsimaffiinnik utoqqarnullu najugaqatigiiffinnik pisariitsumik takusassiineq

iTWOfm nanvn	Atorneqarnera	sananeqarfia	m ²	Kinguaattoorneq katillugit	Aserfallatsaallineq katillugit	Utoqqarnut inissiatut pitsaassusaanut nalliineq	Inissiap 10-mik nalilernerqarsinnaasunngor-tinnissaanut akia	Innarluutilinnut piukkunnassusaanut nalliineq	Innarluutilinnut piukkunnarsannaasut qaavatigut akia
Atammik B-1132	Utoqqarnut inissiaq	1990	48	44.500	135.000	8,57	101.400	7,66	161.400
Atammik B-1133	Utoqqarnut inissiaq	1990	48	37.500	135.000	8,57	101.400	7,66	161.400
Atammik B-1134	Utoqqarnut inissiaq	1990	48	48.900	135.000	8,57	101.400	7,66	161.400
Atammik B-1135	Utoqqarnut inissiaq	1990	48	45.500	135.000	8,57	101.400	7,66	161.400
Maniitsoq B-1010	Utoqqarnut inissiaq	1984	630	1.268.500	2.052.000	6,58	215.000	6,28	228.000
Maniitsoq B-1378	Utoqqarnut inissiaq	2013	358,32	258.000	631.550	9,45	45.500	9,45	45.500
Maniitsoq B-1379	Utoqqarnut inissiaq	2013	358,32	258.000	628.050	9,35	65.500	9,35	65.500
Maniitsoq B-1380	Utoqqarnut inissiaq	2013	238,88	1.000	438.000	9,35	65.500	9,35	65.500
Maniitsoq B-1399	Utoqqarnut inissiaq	2016	1000	270.600	510.000	8,94	47.500	8,94	47.500
Napasq B-1104	Utoqqarnut inissiaq	1990	53	14.000	161.000	9,43	95.000	8,12	118.000
Napasq B-1105	Utoqqarnut inissiaq	1990	53	38.000	161.000	9,43	95.000	8,12	118.000

Napasoq B-1106	Utoqqarnut inissiaq	1990	53	90.000	161.000	9,43	95.000	8,12	118.000
Napasoq B-1107	Utoqqarnut inissiaq	1990	53	38.000	161.000	9,43	95.000	8,12	118.000
Sarfannugit B-1502	Utoqqarnut inissiaq	1998	165	160.000	820.000	6,66	143.600	5,22	236.000
Sisimiut B-1281	Utoqqarnut inissiaq	1987	226,4	177.000	752.100	7,92	120.600	6,32	212.800
Sisimiut B-1282	Utoqqarnut inissiaq	1988	226,4	177.000	897.100	7,92	120.600	6,32	212.800
Sisimiut B-1283	Utoqqarnut inissiaq	1989	226,4	177.000	872.100	7,92	120.600	6,32	212.800
Sisimiut B-1524	Utoqqarnut inissiaq	1998	616,7	30.000	659.600	9,28	52.500	7,98	112.500
iTWO	Atorneqarnera	sananeqarfia	m²	Kinguaattoorneq katillugit	Aserfallatsaallineq katillugit	Utoqqarnut inissiatut pitsaassusaanut nalililneq	Inissiap 10-mik nalilerneqarsinnaasunngor-tinnissaanut akia	Innarluutilinnut piukkunnassusaanut nalililneq	Innarluutilinnut piukkunnarsarnissaanut qaavatigut akia
Sisimiut B-1525	Utoqqarnut inissiaq	1998	616,7	30.000	659.600	8,4	239.600	6,7	194.600
Sisimiut B-1526	Utoqqarnut inissiaq	1998	616,7	30.000	659.600	9	64.600	7,7	124.600
Sisimiut B-2000	Utoqqarnut inissiaq	2013	684	30.000	988.800	9,7	50.000	9,6	50.000
Sisimiut B-2064	Utoqqarnut inissiaq	2016	1293	319.200	339.200	8,85	174.000	9,35	164.000
Kangamiut B-1252	Utoqqarnut angerlarsimaffik	1998	300	141.800	318.500	Ilaassanngilaq	Ilaassanngilaq	Ilaassanngilaq	Ilaassanngilaq
Maniitsoq B-1343	Utoqqarnut angerlarsimaffik	2008	2932	1.608.500	2.233.000	Ilaassanngilaq	Ilaassanngilaq	Ilaassanngilaq	Ilaassanngilaq

Sisimiut B-1037	Utoqqarnut angerlarsimaffik	1984	2400	0	3.122.000	Ilaassanngilaq	Ilaassanngilaq	Ilaassanngilaq	Ilaassanngilaq
------------------------	--------------------------------	------	------	---	-----------	----------------	----------------	----------------	----------------

Ilanngussaq 4 Kommune Qeqertalimmi utoqqarnut inissianik, utoqqaat angerlarsimaffiik utoqqarnullu najugaqatigiiffinnik pisariitsumik takusassiineq

iTWO fm nanvn	Atorneqarnera	sananeqarfia	m ²	Kinguaattoorneq katillugit	Aserfallatsaaliineq katillugit	Utoqqarnut inissiatut pitsaassusaanut nalliineq	Inissiap 10-mik nalilerneqarsinnaasunngor-tinnissaanut akia	Innarluutilinnut piukkunnassusaanut nalliineq	Innarluutilinnut piukkunnarsannaasut qaavatiqut akia
Kangaatsiaq B-667	Utoqqarnut angerlarsimaffik	1990	518	1.309.035	1.207.170	Ilaassanngilaq	Ilaassanngilaq	Ilaassanngilaq	Ilaassanngilaq
Qasigiannugit B-779	Utoqqarnut Angerlarsimaffik	0	507	76.725	577.750	Ilaassanngilaq	Ilaassanngilaq	Ilaassanngilaq	Ilaassanngilaq
Qeqertarsuaq B-474	Utoqqarnut Angerlarsimaffik	1973	334	421.972	714.000	Ilaassanngilaq	Ilaassanngilaq	Ilaassanngilaq	Ilaassanngilaq
Aasiaat B-27	Utoqqarnut Angerlarsimaffik	1958	1874	25.414	2.516.980	Ilaassanngilaq	Ilaassanngilaq	Ilaassanngilaq	Ilaassanngilaq
Qasigiannugit B-679	Utoqqarnut inissiaq	1985	209	17.500	1.482.500	7,63	316.800	6,93	-
Qasigiannugit B-693	Utoqqarnut inissiaq	1987	292,6	-	2.286.950	7,6	225.800	6,9	245.800
Qeqertarsuaq B-804	Utoqqarnut inissiaq	2005	50	27.800	108.000	7,22	225.400	6,19	214.400
Qeqertarsuaq B-805	Utoqqarnut inissiaq	2005	50	26.000	108.000	7,22	225.400	6,19	214.400
Qeqertarsuaq B-806	Utoqqarnut inissiaq	2005	50	26.000	108.000	7,22	225.400	6,19	214.400

Qeqertarsuaq B-807	Utoqqarnut inissiaq	2005	50	26.000	108.000	7,22	225.400	6,19	214.400
Qeqertarsuaq B-808	Utoqqarnut inissiaq	2005	50	26.000	108.000	7,22	225.400	6,19	214.400
Qeqertarsuaq B-809	Utoqqarnut inissiaq	2005	50	30.500	108.000	7,22	225.400	6,19	214.400
Qeqertarsuaq B-811	Utoqqarnut inissiaq	2005	50	26.000	108.000	7,22	225.400	6,19	214.400
Qeqertarsuaq B-818	Utoqqarnut inissiaq	2008	50	69.600	90.500	7,22	222.000	6,42	256.000
Qeqertarsuaq B-819	Utoqqarnut inissiaq	2008	50	74.600	90.500	7,22	222.000	6,42	256.000

iTWOfm nanvn	Atoqeqarnera	sananeqarfa	m ²	Kinguaattoorneq katillugit	Aserfallatsaaliineq katillugit	Utoqqarnut inissiatut pitsaassusaanut nalliineq	Inissiap 10-mik nalilerneqarsinnaasunngor-tinnissaanut akia	Innarluutilinnut piukkunnassusaanut nalliineq	Innarluutilinnut piukkunnarsarnissaanut qaavatiqut akia
Qeqertarsuaq B-821	Utoqqarnut inissiaq	2008	50	67.600	90.500	7,22	222.000	6,42	256.000
Qeqertarsuaq B-823	Utoqqarnut inissiaq	2008	50	66.100	90.500	7,22	222.000	6,42	256.000
Qeqertarsuaq B-824	Utoqqarnut inissiaq	2008	50	66.100	88.500	7,22	222.000	6,42	256.000
Qeqertarsuaq B-825	Utoqqarnut inissiaq	2008	50	66.100	88.500	7,22	222.000	6,42	256.000
Aasiaat B-1303	Utoqqarnut inissiaq	1995	46,4	7.150	217.740	8,22	82.000	7,82	135.000
Aasiaat B-1304	Utoqqarnut inissiaq	1995	46,4	16.720	217.740	8,22	82.000	7,82	135.000
Aasiaat B-1305	Utoqqarnut inissiaq	1995	46,4	16.500	217.740	8,22	82.000	7,82	135.000
Aasiaat B-1306	Utoqqarnut inissiaq	1995	46,4	27.120	217.740	8,22	82.000	7,82	135.000
Aasiaat B-1307	Utoqqarnut inissiaq	1995	46,4	60.600	187.740	8,22	82.000	7,82	135.000

Aasiaat B-1308	Utoqqarnut inissiaq	1995	46,4	5.200	217.740	8,22	82.000	7,82	135.000
Aasiaat B-1309	Utoqqarnut inissiaq	1995	46,4	7.150	217.740	8,22	82.000	7,82	135.000
Aasiaat B-1310	Utoqqarnut inissiaq	1995	46,4	8.470	217.740	8,22	82.000	7,82	135.000
Aasiaat B-1311	Utoqqarnut inissiaq	1995	46,4	16.775	217.740	8,22	82.000	7,82	135.000
Aasiaat B-1312	Utoqqarnut inissiaq	1995	46,4	16.445	217.740	8,22	82.000	7,82	135.000
Aasiaat B-1313	Utoqqarnut inissiaq	1995	46,4	11.000	217.740	8,22	82.000	7,82	135.000
Aasiaat B-1314	Utoqqarnut inissiaq	1995	46,4	39.380	236.220	8,22	82.000	7,82	135.000
Aasiaat B-1315	Utoqqarnut inissiaq	1995	46,4	7.150	217.740	8,22	82.000	7,82	135.000
Aasiaat B-1316	Utoqqarnut inissiaq	1995	46,4	11.660	217.740	8,22	82.000	7,82	135.000
Aasiaat B-1401	Utoqqarnut inissiaq	2000	111	60.770	187.500	9,2	126.500	9,1	72.000
Aasiaat B-1402	Utoqqarnut inissiaq	2000	55,3	70.175	187.500	9,2	126.500	9,1	72.000
Aasiaat B-1403	Utoqqarnut inissiaq	2000	111	41.100	187.500	8,7	77.000	9,1	72.000

iTWOfm nanvn	Atorneqarnera	sananeqarfia	m ²	Kinguaattoorneq katillugit	Aserfallatsaaliineq katillugit	Utoqqarnut inissiatut pitsaassusaanut nalliineq	Inissiap 10-mik nallerneqarsinnaasunngortinnissaanut akia	Innarluutilinnut piukkunnassusaanut nalliineq	Innarluutilinnut piukkunnarsarnissaanut qaavatigut akia
Aasiaat B-1404	Utoqqarnut inissiaq	2000	110,6	41.350	187.500	8,2	287.000	8,6	-

Ilanngussaq 5 Avannaata Kommuniani utoqqarnut inissianik, utoqqaat angerlarsimaffiiniq utoqqarnullu najugaqatigiiffinnik pisariitsumik takusassiineq

iTWOfm nanvn	Atorneqarnera	sananeqarfia	m ²	Kinguaattoorneq katillugit	Aserfallatsaaliineq katillugit	Utoqqarnut inissiamut pitsaasumut nalliineq	Inissiap 10-mik nalilerneqarsinnaasunngortinnissaanut akia	Innarluutilinnut piukkunnassusaanut nalliineq	Inarluutilinnut qaavatigut piukkunnarsannaanut akia
Upernavik B-1091	Utoqqaat angerlarsimaffiat	1997	573	925.928	2.311.178	Ilaassanngilaq	Ilaassanngilaq	Ilaassanngilaq	Ilaassanngilaq
Uummannaq B-180	Utoqqaat angerlarsimaffiat	1967	1800	285.000	2.217.000	Ilaassanngilaq	Ilaassanngilaq	Ilaassanngilaq	Ilaassanngilaq
Ilulissat B-127	Utoqqaat angerlarsimaffiat	1955	1586	459.150	1.720.500	Ilaassanngilaq	Ilaassanngilaq	Ilaassanngilaq	Ilaassanngilaq
Qaanaaq B-400	Utoqqaat angerlarsimaffiat	1997	741	44.600	1.055.000	Ilaassanngilaq	Ilaassanngilaq	Ilaassanngilaq	Ilaassanngilaq
Qeqertaq B-1396	Utoqqarnut inissiaq	1992	43	-	406.200	5,07	405.980	4,34	368.200
Upernavik B-786	Utoqqarnut inissiaq	1975	43	205.500	255.500	5,88	-	3,93	-
Ilulissat B-1333	Utoqqarnut inissiaq	1988	86,6	106.770	203.700	6,23	244.000	5,33	337.000
Upernavik B-570	Utoqqarnut inissiaq	1968	116,4	53.760	1.856.950	6,3	1.244.000	4,89	-
Ilulissat B-1527	Utoqqarnut inissiaq	1996	62	94.900	357.900	6,9	111.300	6,69	244.200
Qaanaaq B-404	Utoqqarnut inissiaq	1997	54,6	69.250	81.900	6,97	159.700	5,87	-
Qaanaaq B-402	Utoqqarnut inissiaq	1997	54,6	95.445	57.720	6,97	159.700	5,87	-
Qaanaaq B-403	Utoqqarnut inissiaq	1997	54,6	90.830	57.720	6,97	159.700	5,87	-
Qaanaaq B-401	Utoqqarnut inissiaq	1997	54,6	79.450	57.720	6,97	159.700	5,87	257.700
Ilulissat B-1487	Utoqqarnut inissiaq	1995	52,5	83.360	79.750	7,47	196.600	6,55	219.600

Ilulissat B-1488	Utoqqarnut inissiaq	1995	52,5	63.660	79.600	7,47	196.600	6,55	219.600
Ilulissat B-1489	Utoqqarnut inissiaq	1995	52,5	70.660	79.600	7,47	196.600	6,55	219.600

iTWOfm nanvn	Atoqqarnut inissiaq	sananeqarfia	m ²	Kinguaattoorneq katillugit	Aserfallatsaaliineq katillugit	Utoqqarnut inissiamut pitsaasumut nailiineq	Inissiap 10-mik nalilerneqarsinnaasunngortinnissaanut akia	Innarluutilinnut piukkunnassusaanut nailiineq	Inarluutilinnut qaavatigut piukkunnarsannaasut akia
Ilulissat B-1490	Utoqqarnut inissiaq	1995	52,5	90.110	59.800	7,57	190.600	6,75	213.600
Ilulissat B-1564	Utoqqarnut inissiaq	2000	56,3	41.675	82.200	8,5	62.000	7,7	177.000
Ilulissat B-1562	Utoqqarnut inissiaq	2000	56,3	47.675	82.200	8,5	62.000	7,7	177.000
Ilulissat B-1566	Utoqqarnut inissiaq	2000	56,3	43.675	82.200	8,5	62.000	7,7	177.000
Ilulissat B-1561	Utoqqarnut inissiaq	2000	56,3	41.875	82.200	8,5	62.000	7,7	177.000
Ilulissat B-1560	Utoqqarnut inissiaq	2000	56,3	46.825	82.200	8,5	62.000	7,7	177.000
Ilulissat B-1565	Utoqqarnut inissiaq	2000	56,3	39.125	82.200	8,5	62.000	7,7	177.000
Ilulissat B-1611	Utoqqarnut inissiaq	2001	56,3	24.000	118.225	9	68.400	8,3	123.400
Ilulissat B-1610	Utoqqarnut inissiaq	2001	56,3	10.900	124.750	9	68.400	8,3	123.400
Ilulissat B-1608	Utoqqarnut inissiaq	2001	56,3	6.850	124.750	9	68.400	8,3	123.400
Ilulissat B-1609	Utoqqarnut inissiaq	2001	56,3	10.900	124.750	9	68.400	8,3	123.400
Ilulissat B-1612	Utoqqarnut inissiaq	2001	56,3	26.450	124.750	9	68.400	8,3	123.400
Ilulissat B-1613	Utoqqarnut inissiaq	2001	56,3	12.950	124.750	9	68.400	8,3	123.400
Ikerasak B-1755	Utoqqarnut inissiaq	2004	139	-	305.400	9,3	51.780	8,8	109.000
Ilulissat B-1842	Utoqqarnut inissiaq	2008	360	63.700	363.000	9,36	60.300	8,46	68.300
Upernavik B-139	Utoqqaat najugaqarigiiffiat	1953	115	43.605	6.480	Ilaassanngilaq	Ilaassanngilaq	Ilaassanngilaq	Ilaassanngilaq

Kangersuatsiaq B1368	Utoqqaat najugaqarigiiffiat	1995	150	-	696.210	Ilaassanngilaq	Ilaassanngilaq	Ilaassanngilaq	Ilaassanngilaq
Qaarsut 1826-27	Utoqqaat najugaqarigiiffiat	2008	171	13.000	230.000	Ilaassanngilaq	Ilaassanngilaq	Ilaassanngilaq	Ilaassanngilaq
Saatut B-1824	Utoqqaat najugaqarigiiffiat	2008	171	84.000	170.000	Ilaassanngilaq	Ilaassanngilaq	Ilaassanngilaq	Ilaassanngilaq

Ilanngussaq 6 – Pissutsinut nalunaarusiamut naleqqunneranullu naliliinermut assersuut.

Sanaartortitsisoq: Namminersorlutik Oqartussat



B-3129 Nuummi

Utoqqarnut inissianik

Pissutsinut nalunaarsuineq

Nuuk

Suliarineqarpoq septembari 2017



Masanti A/S - Postboks 1420 tlf.
311825 - mail. masanti@masanti.gl
Masanti A/S sags nr. 1703

Imarisai

AALLAQQAASIUT:	3
ILLU PILLUGU PAASSISSUTISSAT:	3
Illumut tunngaviusumik paassissutissat.....	3
AVATANGIISIT	3
ILLUP QANOQ INNERANIK TAMAKKIISUMIK NALILIINEQ	4
Sananeqaataa qaavilu.....	5
Teknikkikkut atortorissaarutit.....	6
UTOQQARNUT INISSIAP NALEQQUNNERANIK NALILIINEQ	8

Ilanngussanut takussutissaq:

Ilanngussaq 1: Qanoq inneranut inissisimaffinnut nalinginnaasumik nassuiaat

Ilanngussaq 2: Utoqqarnut inissiap naleqqunneranik naliliineq

Aallaqqaasiut:

Kalaallit Nunaanni utoqqarnut inissianik utoqqarnull angerlarsimaffinnik tamanik nalunaarsuinermit nalunaarusiaq manna ilaavoq Masanti A/S-imit suliarineqartoq.

Nalunaarusiami matumani illup massakkut qanoq innera nalilersorneqarpoq illullu qava, sananeqaataa teknikkikkullu atortorissaarutit nalunaarsorneqarlutik.

Aserfallatsaalisariaqavissut kiisalu aserfallatsaaliinissamut ukiuni qulini pilersaarut Namminersorlutik Oqartussat facility management iTWOfm-imut allattorneqarsimavoq.

iTWOfm-imi illumut fil-it ataanni illup assingi nassaassaapput.

Illu pillugu paasissutissat

Illumut tunngaviusumik paasissutissat

Illoqarfiup/nunaqarfiup aqqa:	Nuuk	B-nr.:	3129
Ukioq sananeqarfia:	1998	Quleriit amerlassusaat:	2
Toqqaviata annertussusaa	267 m ²	Inissiat amerlassusaat:	12
Annertunerusumik aserfallatsaaliineq kingulleq	Soqanngilaq		
Illup atornerqarnera:	Utoqqarnut inissiat		
Kommune:	Sermersooq		
Illumik atuisoq:	Namminersorlutik Oqartussat		
Eqqissimatitaanissaanut killiffik:	Soqanngilaq		

Avatangiisit

Nalunaarsuinermit atatillugu PCB, oqauk akuutissalluunniit allat uuttortarneqanngillat.

Illup ataatsimut qanoq inneranik nalilersuineq

Illup qanoq inneranik naliliinissamut pissutsinut inissisimaffiit 0, 1, 2 aamma 3 atornerqarput. 0 pitsaanersaavoq, ilanngussaq 1 takuuk. Illup ilai assigiinngitsut nailersorneqarsimapput ataatsimoortumillu nalilersuisoqarluni.

Illup ilaa	Pissutsit inissisimaffii 0 - 3	Oqaaseqaatit
Illup saava	2	Sallilikkat marlussuit taarserneqassapput.
Qaliata qalliutaa	0	
Aniinganeq qaliatalu sinaavisa salliliai	2	Aniinganerisa salliliartai qalipanneqassapput.
Toqqavia	0	
Igalaat	2	Igalaat ussiitsut taarsissapput.
Matut silarliit	2	Matut ussiitsut iluarsinngikkunik taarsissapput.
Sullumi, qaliani naqqullu ataani oqorsaait	-	
Naqqi	0	
Illup iluani matut	1	Matu ataaseq iluarsineqassaaq.
Igaffik	1	Kuuffik misissorneqassaaq.
Uffarfik	1	Natermi kuuffik milittooqqavoq.
Perusuersartarfiit	0	

Sallilikkat marlussuit taarserneqassapput.

Aniinganerisa qaliatalu salliliartai qalipanneqassapput.

Igalaat matullu ussiitsut iluarsineqassapput.

Kuuffik misissorneqassaaq illullu iluani matu iluarsineqarluni. **Sananeqaataa**

qaavilu

Illup saavata qaava	Sallilikkanik qaaqarpoq	Oqorsaait mm-imut	150/175
Silataani iikkap sananeqaataa	Illup saarngi katitikkat betonilu		
Qaliata qalliutaa	Pappiliarsuit	Oqorsaait mm-imut	200
Qaliata sananeqaataa	Qaliata quassuttuui	Qilaavata sivinganera	12,5 grader
Qaliani aniinganeq	Aap	Aniingasua mm-imut	500
Igalaat suuneri	Rationel	Igalaat pisoqaassusaat	Ukiut 5 / 19
Matut suuneri	Sweedoor	Matut silarliit pisoqaassusaat	Ukiut 19

Qaliani igalaat	Naagga	Qaliani igalaat pisoqaassusaat.	-
Nateq	Natermut sallilikkat /linoleum	Oqorsaat mm-imut	200
Naqqup ataa	Naagga	Oqorsaat mm-imut	-
Naqqup ataani qaarusuusaaq	Aap	Oqorsaat mm-imut	150
Betonimik toqqavik	Aap	Betonip issussusaa	180
Qalia	Aap	Isolering mod loftrum i mm	200
Sullut	Aap	Isolering mod skakte i mm	50
Silami tummeqqat	Aap	Udvendig rampe	Aap
Quleriit qaavi	Aap	Indvendige trapper	Naagga

Nukkimmik pitsanngorsaaneq: Igalaat matullu ukiut qulit qaangiutinnginneranni taarserneqartariaqarput.

Teknikkikkut atortorissaarutit

Igaffiit	Aap	Amerlassuaat	12
Pisoqaassusaat	Ukiut19	Kingullermik aserfallatsaalineqarnera	-
Uffarfiit	Aap	Amerlassuaat	12
Pisoqaassusaat	Ukiut 19	Kingullermik aserfallatsaalineqarnera	-
Perusuersartarfiit	Aap	Amerlassuaat	12
VVS-imut ikkussukkat			
<u>Kuuffiit ikkussukkat</u>			
Ruujorinik systemit	Ersinngillat	Teknikrumimi natermi kuuffik	Naagga
Pumpebrøndi	Naagga	Kinnganeranut tanki	Naagga
Kuuffik	Aap	Nunami errortuutikoq	Naagga
Pisoqaassusaat	1998	Kingullermik aserfallatsaalineqarnera	-
<u>Kiassarnermut ikkussukkat</u>			
Kissarsuut uuliatortoq	Naagga	Fjernvarme	Naagga
Innaallagiasaq - kiassarneq	Aap	Ruujorinik systemit	Ersinngillat

Anslået alder for system	-	Tunisassiortoq	-
Sunniutaa (KW)	-	Ikuallaat	-
Serie nr.	-	Kingullermik aserfallatsaalineqarnera	-
<u>Imermut ikkussukat</u>			
Ruujorinik systemit	Ersinngillat	Imermik pilersuineq	Aalajangersimasoq
Kissartumut imiisivik (suussusaa)	-	Qerruttuunnginnissamut qularnaarut	-
Angissusaa	-	Tunisassiortoq	-
Systemip pisoqaassusaa	-	Kingullermik aserfallatsaalineqarnera	-
Ikuallannermut slange	Aap	Qilaavanit seqqittaat	Naagga
<u>Silaannarissarneq</u>			
Mekaniskimik milluaaneq	Naagga	Oqimaaqatigiissumik silaannarissaat	Aap
Silaannarissarfiit	Aap	Aalamik milluaat	Aap
Ikuallattoornermi silaannarissaat	Naagga	Ikuallattoornermi silaannarissarfik matusartoq (motoori)	Naagga
Tunisassiortoq	-	Angisussusaa	-
Serie nr.	-	Kingullermik aserfallatsaalineqarnera	-
Systemip pisoqaassusaa	-	Kingullermik aserfallatsaalineqarnera	-
<u>Teknisk isolering</u>			
Naqqup ataani qaarususami	Aap	Teknikrumimi	Aap
Sullumi	Aap	Qaliani	Aap

Innaallagissamut ikkussukat			
<u>Qullit</u>			
Qaamanermik aqutsissut	Naagga	LED-mik qulleq	Naagga
Pærit sipaarutit/ruujorit	Aap	Pære aamatut ikumasoq	Naagga

<u>Innaallagissamut ikkussukkat atasut</u>			
Kappuffik nunamut attavilik	Aap	HPFI-mik unittaaat	Aap
Ikkufferujussuaq	Aap	ABA-mik katersuuffik	Naagga
Ikuallattoqarneranik kalerrisaarutit	Naagga	Kalerrisaarut	Naagga
Elevatori	Naagga	Tunisassiortoq	-
Ukioq ikkunneqarfia	-	Serienr.	-

Utoqqarnut inissiap naleqqunneranik naliliineq

Atornissaanut illup naleqqunnera nalielrumallugu illup annertussusaa aaqqissorneralu llanngussaq 2-mi "Utoqqarnut inissiatsialak"-mi allanneqarsimapput.

Tamanna tunngavigalugu naleqqunneranik naliliineq naatsorsorneqarsimavoq [Naliliineq 0-imit 10mut].

Utoqqarnut inissiaq una imak nalilerneqarpoq:

Utoqqarnut inissiaq tamakkiisumik nalilerneqarnera 9,6.

Utoqqarnut inissiap kørrestolimut tamakkiisumik nalilerneqarnera 9.

Naleqqunneranik naliliinerup takutippaa:

Inissiaq utoqqarnut inissiatut naleqqulluortoq.

Kørrestolimik atuisoqarsinnaavoq.

Illu utoqqarut sulii pitsaanerulersinniarlugu igaffik taarserneqartussangorpat igaffiup illuartinnaasunik atortulersorneqarnissaa eqqarsaatigisariaqarpoq.

Illup naleqqunnera pitsaanerulersinniarlugu allanngortitsinermut aningaasaliisoqarnissaa naatsorsuutigisariaqarpoq. Illup 10-mik nalilerneqarsinnaasunngortinnissaanut qanoq allannguitigisoqassaneranik naliliineq tunngavigalugu naatsorsuisoqarpoq.

Utoqqarnut inissiap 10-mut qaninnerusumik nalilerneqarsinnaasunngortinnissaanut aningaasat illuartinneqartariaqartutut nalilerneqarput 67.000,- kr.-it.

Ilutigitillugu utoqqarnut inissiaq kørrestolimut aaqqissorneqassappat qaavatigut 45.000,- kr.-it illuartinneqartariaqarput.

Pissutsinik nalunaarsuineq

Pissutsit annertussusernerannik nalinginnaasumik nassuiaat

Pissutsip annertussusaa 0	
Iliuusissaq:	Nalunaarsuineq:
Soqanngilaq	Nalunaarsorneqarsimasut ajunngillat qaavi ajoquteqarnerannik ersittoqanngillt tamakkiisumillu atorneqarsinnaallutik.
Pissutsip annertussusaa 1	
Iliuusissaq:	Nalunaarsuineq:
Qaavanik isumaginninneq	Nalunaarsorneqarsimasut ajunngillat tamakkiisumillu atorneqarsinnaallutik, qaavili takussutissartaqarput suliaralugit pitsanngorsagassanik.
Pissutsip annertussusaa 2	
Iliuusissaq:	Nalunaarsuineq:
Qaavanik isumaginninneq iluarsartuussinerlu	Nalunaarsorneqarsimasut ajoquteqalaarput atorsinnaanerallu killeqarlutik. Iluarsaallugit iluarsineqassapput ilaaluunniit taarserlugit qaavilu suliarilluarneqarlutik.
Pissutsip annertussusaa 3	
Iliuusissaq:	Nalunaarsuineq:
Tamakkiisumik iluarsartuussineq taarsiinerluunniit	Nalunaarsorneqarsimasut atorsinnaanngillat. Ikkussukat ilai tamakkiisulluunniit ajoquteqarput amigaataallutilluunniit. Taarserneqassapput tamakkiisumilluunniit iluarsineqarlutik.

Tungaviusumik paasissutissat

Illoqarfik/nunaqarfik:	Nuuk
Kommune	Sermersooq
B-nr.:	B-3129
Illumik piginnittoq	Namminersorlutik Oqartussat

Sanaartukkamut teknikkikkut paasissutissat

Annertussusaa	267	m2
Quleriaat amerlassusaat (ilanngarnagu)	2	
Ukioq sananeqarfia	1998	
Ukiuni qulini kingullerni annertuumik iluarsaanneqarsimava	Nej	
Inissiaq inissiaqatigiinnut ataatsimut B-normulinnut ilaava	Ja	

Attavissaq

Aqutsisoq	
E-mail	
Oqarasuaatip normua:	
Immaqalu predelip oqarasuaataata normua:	

Nalunaarsuineq:

Inissiap annertussusaa ilanngaattissat peereerlugit:	m2
Silarleq	4
Isaariaq/torsuusaq	6,6
Uffarfik/perusuersartarfik	4,62
Sinittarfik	10,5
Ini	
Igaffik	
Igaffik initalik	21,2
Ilassutitut ineeraq	
Toqqorsivik kiassagaq	
Toqqorsivik/qui kiassarneqanngitsoq	
Masanti A/S-imi akisussaasoq	HHJ
Ulloq nalunaarsorneqarfia	18.09.17

Kiassarneqanngitsoq

Utoqqarnut inissiatsialammut
tulleriagassat

Inissiamut isersinnaaneq

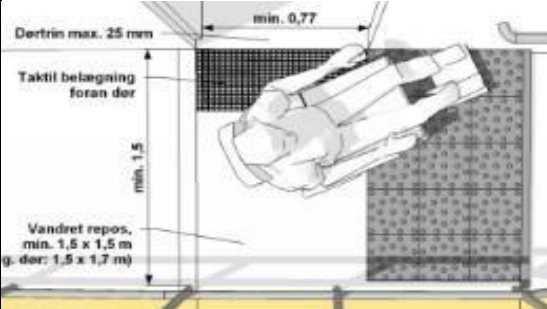
Sammisaq	Itisiliineq	Aap(0)/Naagga(1) /Nalinga
Matup silarliup saava tummeqqat qaavat manissuua?	Matup isertarfiup silatinnguani naqqup portoqataanik manissumik saaqarpoq.	0
Saava qanoq silitsigaa? Cminngorlugu	Illup saavanit sinaakkummut aalajangersimasumulluunniit uuttornera	
Tummeqqat qaavat minnerpaamik 1,5x1,5 meterisut annertussuseqarpoq. Matu silammut ammartarpat 0,2 meterimik illup saava malillu annertusineqassaaq		0
Tummeqqat qaani matup silarliup nunallu akornanni naleqqussaasoqarsimava?	Tummeqqat qaavata nunallu nikingassuaat naleqqussarneqarsinnaavoq iseriartorfiatigut majorallalerneratigulluunniit	0

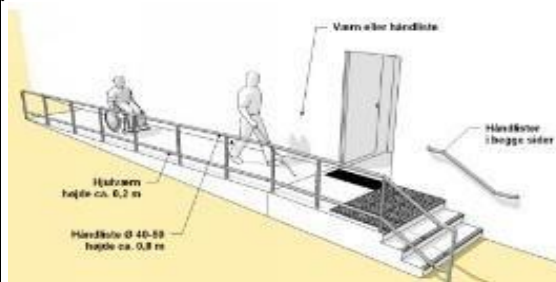
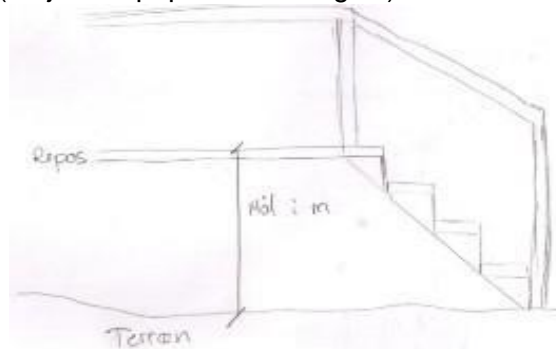
<p>Illup tungaanut ataatsimulluunniit isaarissamut majorallalerneqarsimava?</p>	<p>Iseriartorfimmit tummeqqat qaavanut naleqqussaannermi majorallaliisoqarsinnaavoq, aallartinnerani naanerani lu qaavisa makittarissortaat minnerpaamik 1,5 x 1,5 meteriusariaqarpoq. 1:25-imik sivinganeruppat (meterimut 4 cm) sivinganeralu katillugu 0,6 meteriuppat, singanerit 0,6 meterikkaarlugit makittarissumik qaalerneqassapput. Majorallat sinaakkuserneqarsimassapput minnerpaamik 0,8 meterisut portussusilimmik.</p> 	<p>0</p>
<p>Illup tungaanut majorallaliisoqarsinnaava?</p>	<p>(Peqareerpat akissanngilat)</p>	
<p>Majorallaqanngippat sanasoqarsinnaaneralu periarfissaqarpat majorallammik naleqqussagassaq qaniq portutigaa</p>	<p>Tummeqqat qaanit nunamut uuttortaruk (Majorallaqarpat akissanngilat)</p> 	

Utoqqarnut inissiatsialammut tulleriagassat

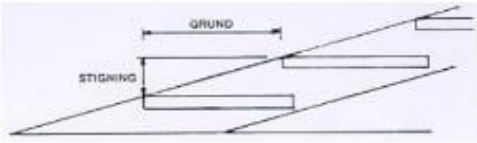
<p>Illumut tummeraqarpa?</p>		<p>0</p>
<p>Elevatoreqarpa? (quleriinnik arlalinnik sanaartortoqarpat utoqqarnullu inissiaq naqqaniit qullasinnerusumiissappat aatsaa akineqassaaq)</p>	<p>Sanaartornermi illut naqqata saniatigut marlunnik qulereeqarpat minnerpaamik ataatsimik elevatoreqassaaq. Elevatorip saani annertussuseq minnerpaamik 1,5 x 1,5 meteriussaaq</p>	<p>1</p>

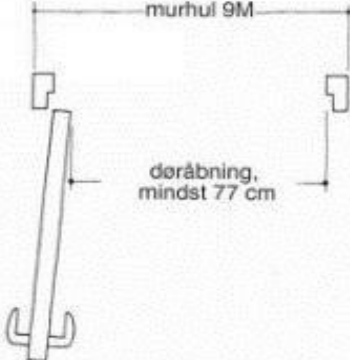
Iseriartorluni aqqummi matullu silarlup silataani qulleqarpa?	Iseriartortarfiit, tummeqqat qaavilu qulleqartariaqarput. Qulleq matup silarliup silataani qaamanerpaassaaq	0
Matup iserfissartaa qanoq silitsigaa? Cm-erinngorlugu		97

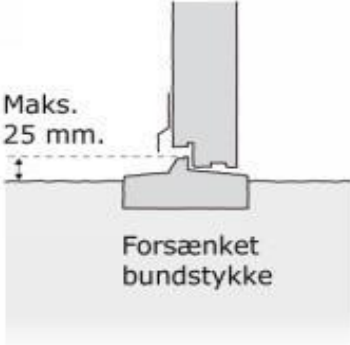
Isaarissami alloriusaq qanoq portutigaa?		2
--	---	---

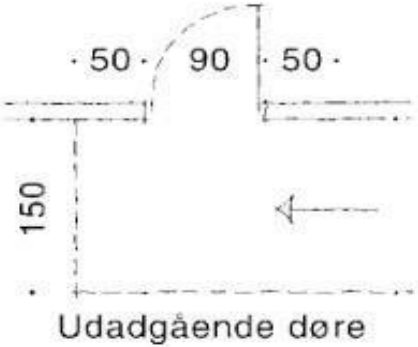
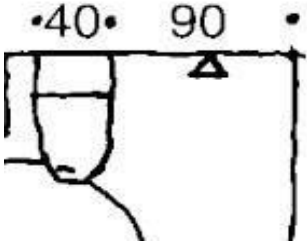
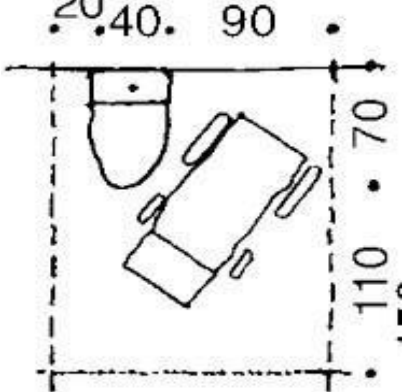

WC uffarfillu

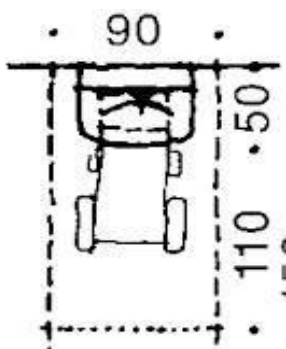
Sammisaq	Itisilineq	Aap(0)/Naagga(1) /nalinga
Isertarfiup naleqataani perusuersartarfeqarlunilu uffarfeqarpa?		0
Matu silammut ammartarpa illersittagaalluniluunniit?	 <p>Udadgående døre</p>	0
Perusuersarfimmit ingerlaffissaq qanoq silitsigaa cm-inngorlugu?		100
Perusuersarfiup eqqaa aalangiussanik atortoqanngitsoq qanoq inissaqartigaa cm-inngorlugu?		150

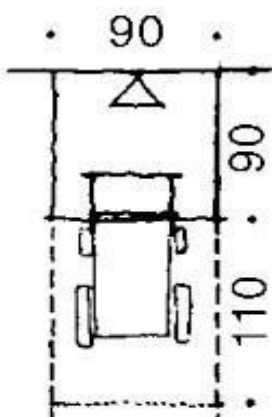
<p>Asaffiup saani aalajangiussanik atortoqanngitsoq qanoq inissaqartigaa cm-inngorlugu?</p>		<p>200</p>
---	--	------------

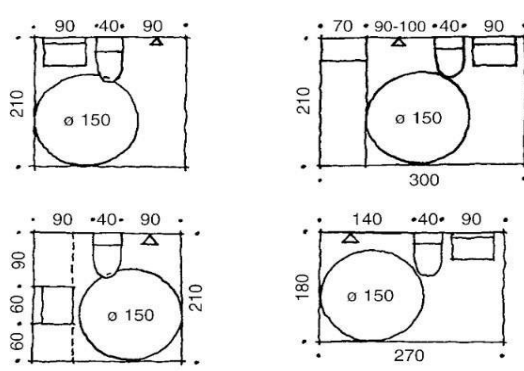
<p>Kuutsitsivigitilluni uffariup saava aalajangiussanik atortoqanngitsoq 110 cm-imik inissaqarpa?</p>		<p>0</p>
---	---	----------

<p>Inimi minnerpaamik 150x150 cm-imik annertussusilimmik illuanut saaffissaqarpa?</p>	<p>Kørestolimik atuisut nammineersinnaasut perusuersartarfimmik uffarfimmillu atuisinnaassappata inuk isersinnaassaaq matulu matorirlugu perusuersartarfimmik saffimmillu atuisinnaalluni.</p> 	<p>0</p>
---	---	----------

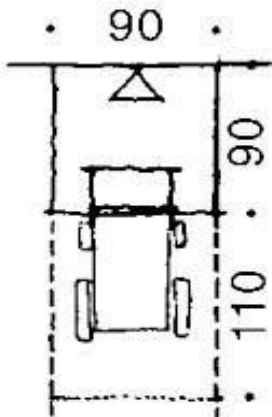
<p>Kørestolimik atuisoq asaffimmik atuisinnaava?</p>	<p>Naqqa manissuuppat kuuffiillu illuartinneqarsimallutikkørestolimi issialluni niut kørestolilu asaffiup ataaniissinnaassapput.</p>  <p>Mål i cm.</p>	<p>0</p>
<p>Asaffiup qaava naqqanit 80 cm-it missaanniippa?</p>	 <p>Mål i cm.</p>	<p>0</p>
<p>Asaffik appartillugulu qullartinneqarsinnaava?</p>		<p>1</p>
<p>Kuutsitsivigaluni uffarfissaq minnerpaamik 90x90 cm-ua?</p>		<p>0</p>

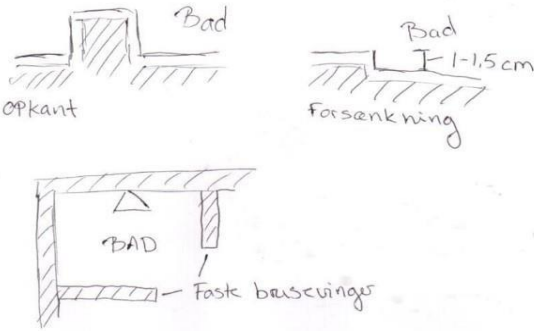
<p>Kuutsitsivigitilluni sinilerneqarsimanngila itinersalerneqarluniluunniit 1,5 cm-imit itinerusumik?</p>	<p>uffarik</p> 	<p>0</p>
---	---	----------

Oqaaseqaatit allat:

Inissiaq

Sammissaq	Itisiliineq	Aap(0)/Naagga(1) /nalinga
-----------	-------------	------------------------------

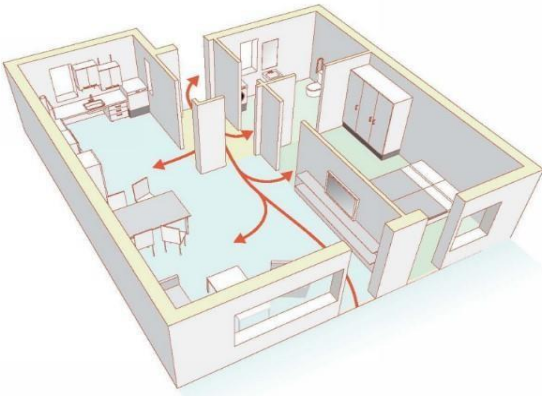
<p>Isertarfiup naleqataani igaffeqarlunilu, ineqarpa, sinittarfeqarluni kiisalu uffarfeqarlunilu perusuersartarfeqarluni?</p>		<p>0</p>
<p>Inissiaq illup iluani qanoq amerlatigisunik matoqarpa?</p>		<p>4</p>
<p>Alloriusat qanoq amerlatigisut 25 mm-imit portuneruppat?</p>		<p>0</p>

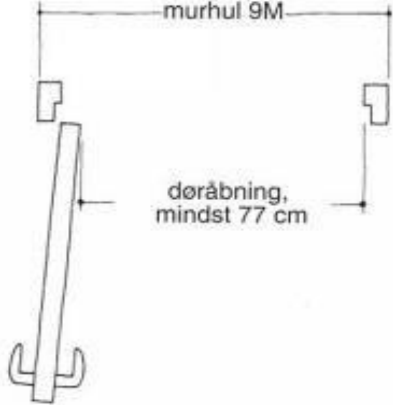
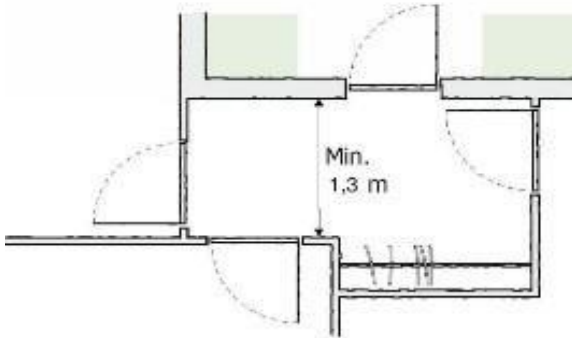
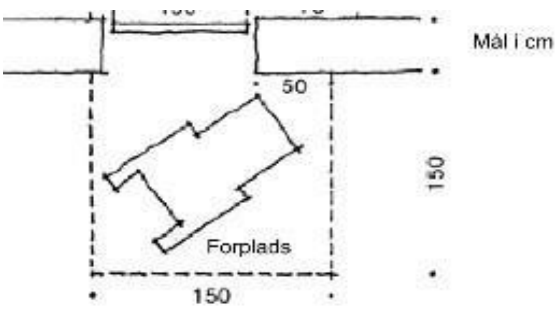
<p>Isertarfiup naleqataani illup iluani matut iserfissartai qanoq amerlatigisut 77 cm-imit aminneruppat?</p>	 <p>Diagram showing a door handle with a horizontal span of 9M and a vertical height of at least 77 cm. The text 'døråbning, mindst 77 cm' is present.</p>	<p>0</p>
<p>Silarleq minnerpaamik 1,3 meterimik silissuseqarpa?</p>	 <p>Diagram showing a door opening with a minimum width of 1.3 m. The text 'Min. 1,3 m' is present.</p>	<p>0</p>
<p>Torsuusaq minnerpaamik 1,3 meterisut silissuseqarpa?</p>		<p>0</p>
<p>Matup isaarissap iluani annertussuseq minnerpaamik 1,5x1,5 meteriua?</p>	 <p>Diagram showing a mat area (Forplads) with dimensions 150x150 cm. The text 'Mål i cm' is present.</p>	<p>0</p>

<p>Igaffik L-itut aaqqissugaava?</p>	<p>Igaffik L-itut aaqqissugaappat suliffiusut akorni qanittunnguussapput; asaffik, nerriviisq suliffissaq, kissarsuutnillataartitsivillu. Kørestolimik atuisumut naleqquttoq</p> 	<p>0</p>
<p>Igaffimmi atortut nuunneqarsinnaappat?</p>	<p>Igaffimmi atortut nuunneqarsinnaasut tassaasinnaapput nerriviit appartillutillu qullartittakkat, qulaani sikaaviit ammukartinneqarsinnaasut il.il. Ataani sikaaviit amusarissallu pisariaqarfiani issiaannarluni nuunneqarsinnaapput</p> 	<p>1</p>

Ilanngussaq 2

Annertussusaanik ilanngaatissat peereerlugit maleqqunnerannik naliliineq

	[m ²]	[m ²]	[%]	[oqim[1-10]]	
Inip taaguutaa:					
Silarleq	4	3	133%	0,2	2%
Isaariaq	6,6	4	165%	0,2	2%
Uffarfik/perusuersartarfik	4,62	4,5	103%	1	10%
Sinittarfik	11	11	95%	0,9	10%
Igaffik initalik	21,2	96%		0,9	10%
Toqqorsivik kiassagaq	0	0%		0	1%
Toqqorsivik/qui kiassarneqanngitsoq	0	0%		0	1%
Annertussuseq kiassarneqartoq ilanngaatissat peereerlugit	46,92	101%			
	Samlet areal. De faktiske forhold	Den gode ældreboliq, norm	Procentvise afvigelse	Mellemregning	

Ini %	1400	0	0%
Igaffik %	1200	0	0%

Utoqqarnut inissiap naleqqunneranik naliliineq

	Ja = 0; Nej = 1	Den gode ældrebolig, norm	De faktiske forhold	Den gode ældrebolig, norm	Procentvise afvigelse	Mellemregning	
	[0/1]	[0/1]	[cm]	[cm]	[%]	[Oqim. [1-10]]	
Inissiamut isersinnaaneq							
Isaarissamut tummeqqat qaavat	0	0			100%	0,3	3%
Tummeqqat qaavisa silissusaa			0	100	100%	0,3	3%
Tummeqqat qaavanut/majorallammut nunamik naleqqussaaneq	0	0			100%	0,1	1%
Majorallak	0	0			100%	0,5	5%
Majorallaqarsinnaanera	0	0			Nalilerneqassaaq		
Majorallammik naligiissarineq			0		0 Akianik		
Tummeqqat qaavannut/ataatsimut	0	0			naatsorsuinerinnarmut 100%	0,5	5%
iseriartortarfimmum tummeqqat							
Inissiamut qullit	0	0			100%	0,2	2%
Matup iserfigineqarsinnaasortaata silissusaa			97	77	100%	0,5	5%
Pingaarnertut isaarissami alloriusaq			2	2,5	100%	0,5	5%
WC uffarfillu							
Isertarfiup naleqataani WC uffarfillu	0	0			100%	1,1	11%
Matu silammoortoq/illersittagaq	0	0			100%	0,5	5%
WC-p saniani soqanngitsup silissusaa			100	90	111%	0,1	1%
Asaffiup qaavanut	0	0			100%	0,2	2%
Kuutsitsivigitilluni uffarfik	0	0			100%	0,3	3%

Kuutsitsivigitilluni uffarik sinaakkuserneqanngitsaq matoqanngitsorlu	0	0		100%	0,3	3%
Inissiaq						
Isertarfiup naleqataani pingaarnertut ini	0	0		100%	0,2	2%
Alloriusat 25 mm-it portunerusut amerlassusaat			0	0	100%	0,1 1%
Matut iserfissaat naammattumik			0	0	100%	0,1 1%
silissuseqanngitsut amerlassusaat						
Silarliup silissusaa	0	0		100%	0,2	2%
Torsuusap silissusaa	0	0		100%	0,2	2%
Igaffik L-itut aaqqissugaq	0	0		100%	0,2	2%
Utoqqarnut inissiap ataatsimut nalilenera						<u>9,6</u>

Kørestolilinnut imminut ikiorsinnaasunut utoqqarnut inissiap naleqqunneranik naliliineq

	Ja = 0; Nej = 1	Den gode ældrebolig, norm	De faktiske forhold	Den gode ældrebolig, norm	Procentvise afvigelse	Mellemregning	
	[0/1]	[0/1]	[cm] [amerl]	[cm] [amerl]	[%]	[Oqim.[1-10]]	
Inissiamut isersinnaaneq							
Isaarissamut tummeqqat qaavat	0	0			100%	0,2	2%
Tummeqqat qaavat 1,5x1,5	0	0			100%	0,5	5%
98							
Nunami naleqqussaaneq	0	0			100%	0,5	5%
Majorallaq	0	0			100%	0,5	5%
Qullit	0	0			100%	0,1	1%
Matup iserfigineqarsinnaanerata silissusaa			97	77	100%	0,5	5%
Silarlermi isertarfimmut alloriusaq			2	2,5	100%	0,5	5%

Inissianut arlalinnik quleriinnut elevatori	1	0		0%	0	1%
Wc og bad						
Isertarfiup naleqataani WC uffarfillu	0	0		100%	0,7	7%
Matu silammoortoq/illersittagaq	0	0		100%	0,1	1%
WC eqqaani soqanngitsup silissusaa		100	90	111%	0,1	1%
Asaffiup saani soqannginnersaq		200	110	182%	0,1	1%
Kuutsitsivigitilluni uffarfiup saani soqannginnersaq		0	110	0%	0	1%
Illuanut saaffissaq 1,5 x 1,5 m	0	0		100%	0,3	3%
Kørestolimik atuisoq asaffimmik atuisinnaavoq	0	0		100%	0,3	3%
Asaffiup qaava	0	0		100%	0,1	1%
Asafik appartillugulu qullarsinnaasoq	1	0		0%	0	3%
Kuutsitsivigitilluni uffarfimmi inissaq	0	0		100%	0,2	2%
Kuutsitsivigitilluni uffarfik sinaakkuserneqanngitsaq matoqanngitsorlu	0	0		100%	0,2	2%
Inissiaq						
Isertarfiup naleqataani ini pingaarneq	0	0		100%	0,2	2%
Alloriusat 25 mm-it sinneqartut amerlassusaat		0	0	100%	0,2	2%
Matut iserfiginissaanut naammattumik silissuseqanngitsut amerlassusaat		0	0	100%	0,1	1%
Silarliup silissusaa	0	0		100%	0,1	1%
Torsuusap silissusaa	0	0		100%	0,1	1%
Isertarfiup eqqaani 1,5 x 1,5 m	0	0		100%	0,1	1%
Igaffik L-itut aaqqissugaq	0	0		100%	0,1	1%
Igaffimmi atortut nussorsinnaasut	1	0		0%	0	1%

**Utoqqarnut inissiamik
kørestolertunut ataatsimut
naliliineq**